

HDMI INTERFACE BOARD

[HDMI INTERFACE CON]

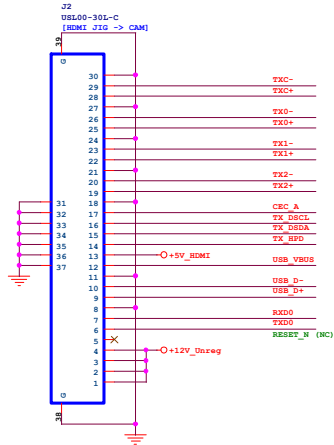

[POWER IN 12V]

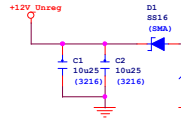

[DC-JACK CON]

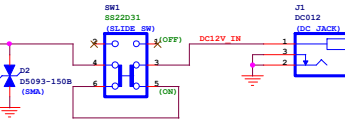

[POWER LED]

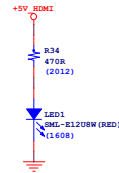

[HDMI CON]

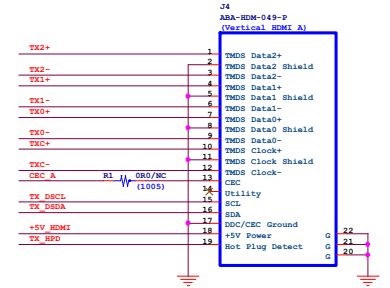

[UART CON]

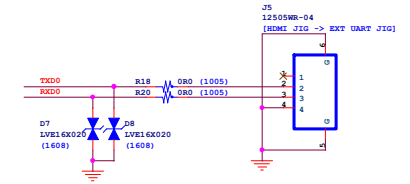

[INTERFACE CON]

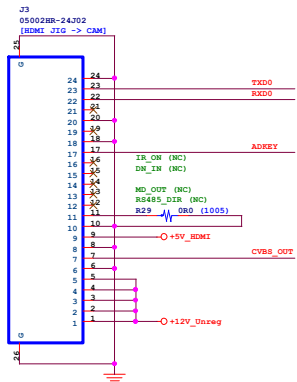

[Joystick S/W]

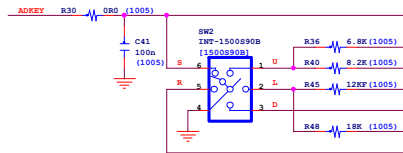

[CVBS CON]

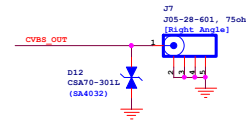

[USB CON]

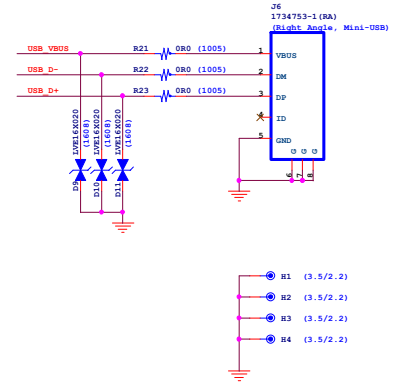

Title		
HDMI INTERFACE BOARD		
Size	Document Number	Rev
	<Doc>	03